

Growing Fish in Cages

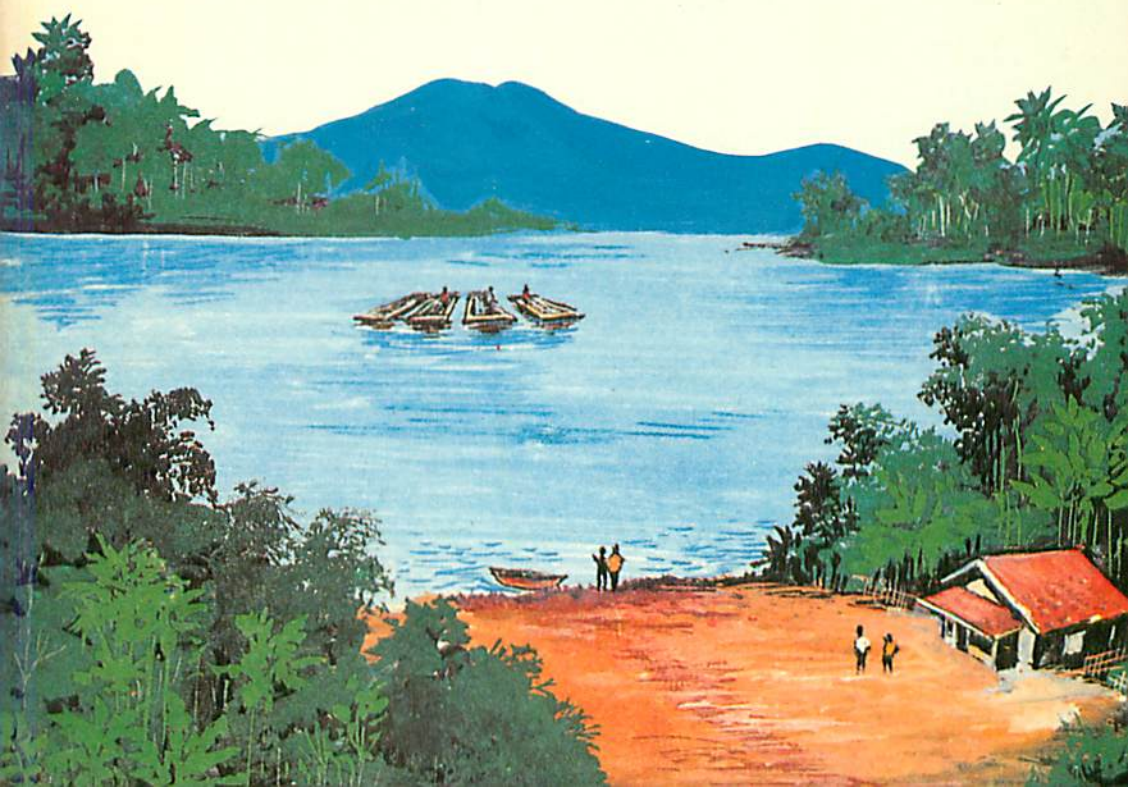

Growing Fish in Cages

by

**Barry A. Costa-Pierce
Gelar Wira Atmadja
Rusydi
Apih Safari**

1989

**Illustrated by: Trya Yudhantara and
Ovidio F. Espiritu, Jr.**

Growing fish in cages

**B.A. Costa-Pierce
G.W. Atmadja
Rusydi
A. Safari**

1989

Published by the Institute of Ecology, Indonesian State Electric Company (IOE UNPAD-PLN), Bandung, Indonesia; and the International Center for Living Aquatic Resources Management, MC P.O. Box 1501, Makati, Metro Manila, Philippines, with funding from the International Bank for Reconstruction and Development.

Printed in Manila, Philippines

Costa-Pierce, B.A., G.W. Atmadja, Rusydi and A. Safari. 1989. Growing fish in cages. ICLARM Education Series 10, 43 p. Institute of Ecology, Indonesian State Electric Company (IOE UNPAD-PLN), Bandung Indonesia, and International Center for Living Aquatic Resources Management, Manila, Philippines.

**ISSN 0116-5720
ISBN 971-1022-75-3**

ICLARM Contribution No. 575

The techniques described here were developed in the Saguling and Cirata Reservoirs in Bandung, Indonesia. They can easily be adapted to other locations.

Produced by

**The Aquaculture and Fisheries Development Project
for the Resettlement of Communities from the
Saguling and Cirata Dam Regions**

A cooperation between the Institute of Ecology, Indonesian State Electric Company (IOE UNPAD-PLN), Bandung, Indonesia; and the International Center for Living Aquatic Resources Management (ICLARM), Manila Philippines, with funding from the International Bank for Reconstruction and Development.

This book is also available in Sundanese (West Java, Indonesia).



What are the advantages of growing fish? People who eat fish are healthy and strong.



Children grow quickly. Worms and other diseases are not caused by eating fish, but by drinking polluted water and eating dirty food.



In any market, fish such as common carp, tilapia, etc. can be purchased rather cheaply.

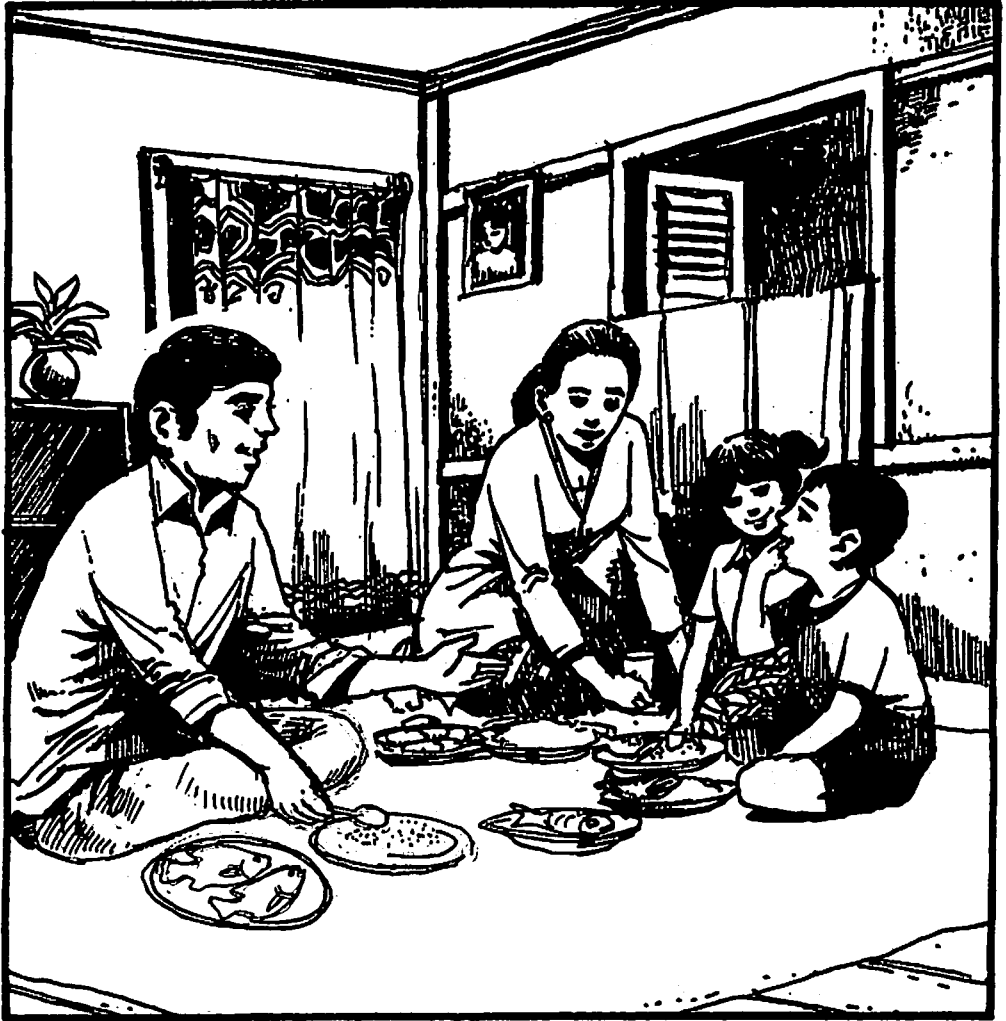

**A family that eats much fish will be healthy and happy.
You can share your favorite fish recipes with your neighbors.**



What are the advantages of growing fish in cages?

- cages are easy and cheap to construct
- cages can be operated cooperatively
- cages are easy to stock and feed
- fish grow fast in cages
- cages are easy to harvest

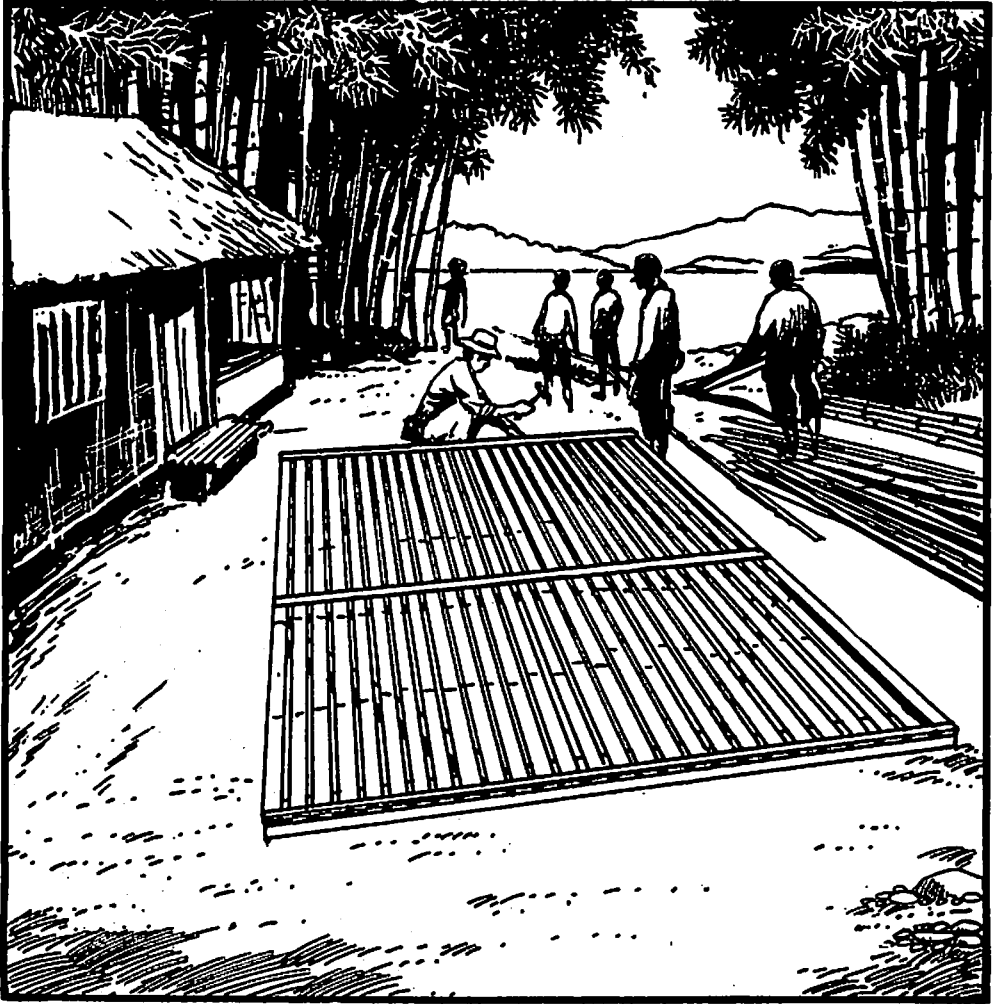

It is easy to construct cages using mainly bamboo.



When the cage is complete, put it in a reservoir or lake.

A cage 4 x 2.5 x 1.75-m deep can be stocked with 35 kg, or 700 small fish of a 50-g size (2-3 finger size).



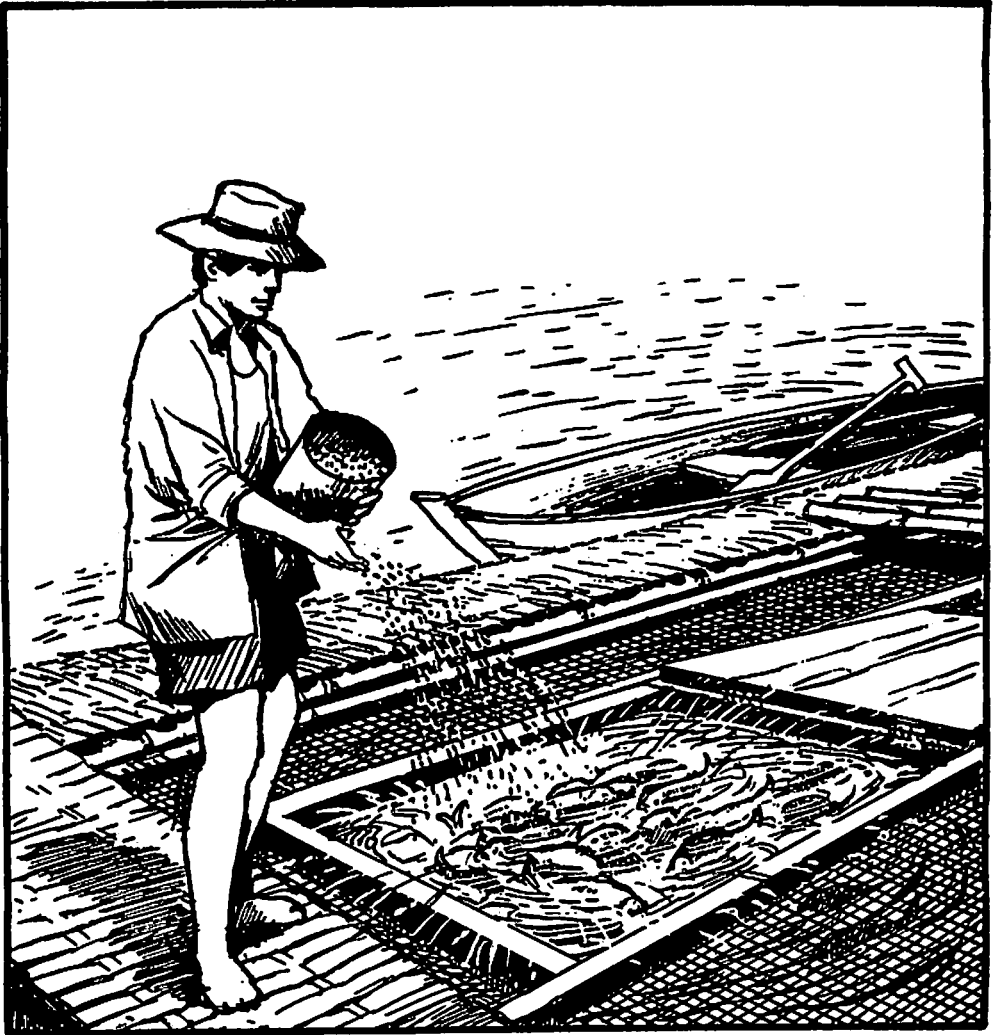

Feed the fish on a regular schedule with pelleted feed.





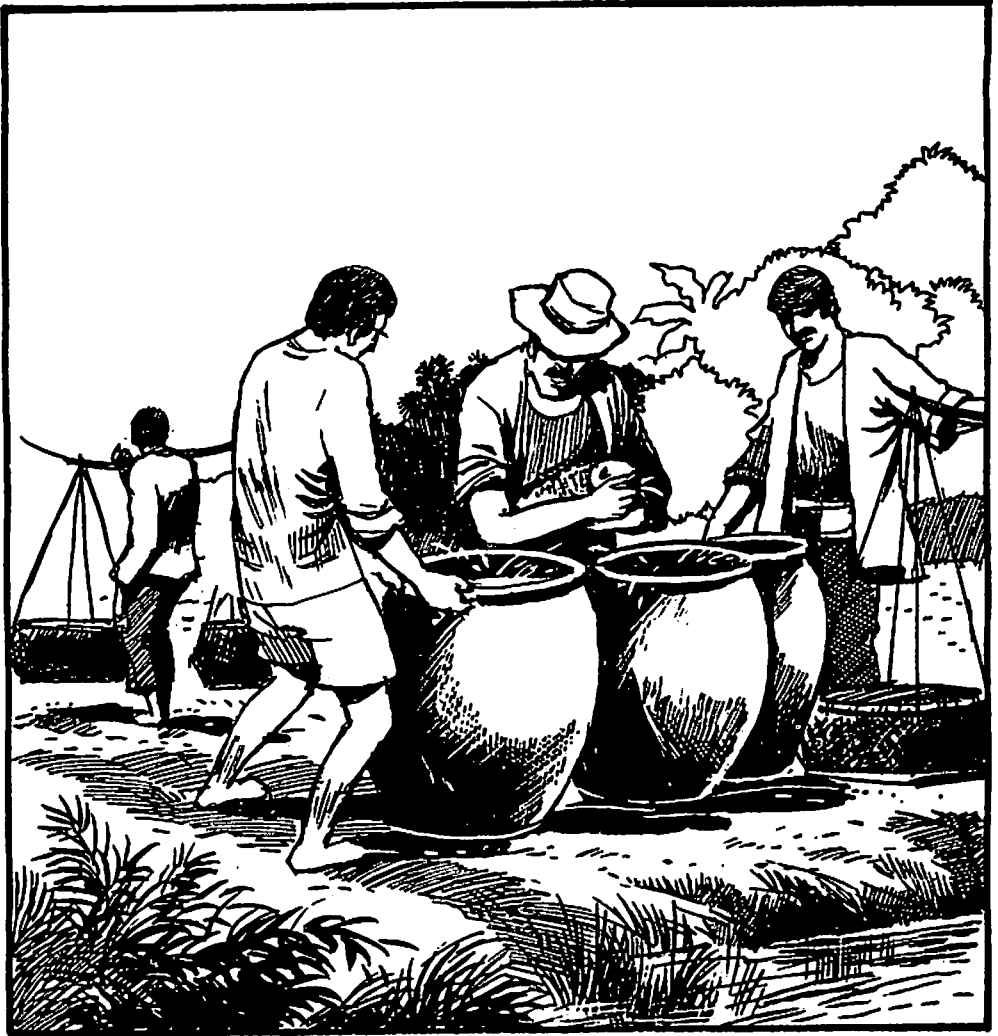

In 90-120 days, you can harvest the fish in the cage.



The large fish can be sold to markets and some can be distributed among members of the fish farming group for direct consumption by their families.

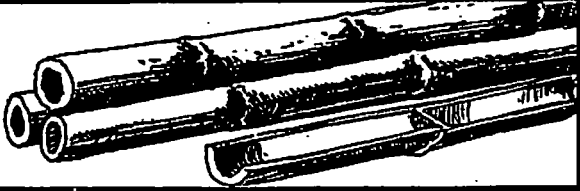
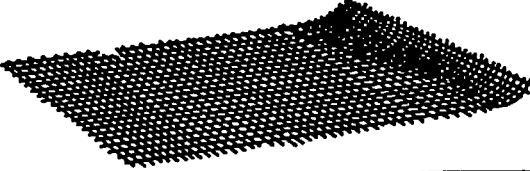

Part of the money from fish sales can be distributed among the group members and the rest saved to buy new seed fish for growing another crop of fish.

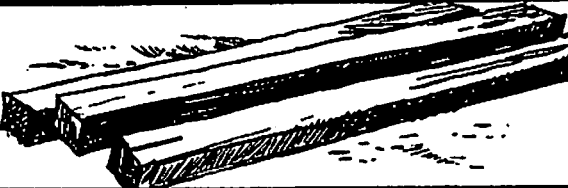
	thick, strong bamboo
	wire mesh
	netting
	plastic rope
	nails
	wood

Some of the materials needed to construct cages can be purchased locally, but others may have to be purchased in town.



To construct a cage, use bamboo split into 4-6 vertical strips. The mesh size of the cage should be smaller than the width of the smallest fingerlings stocked.

15

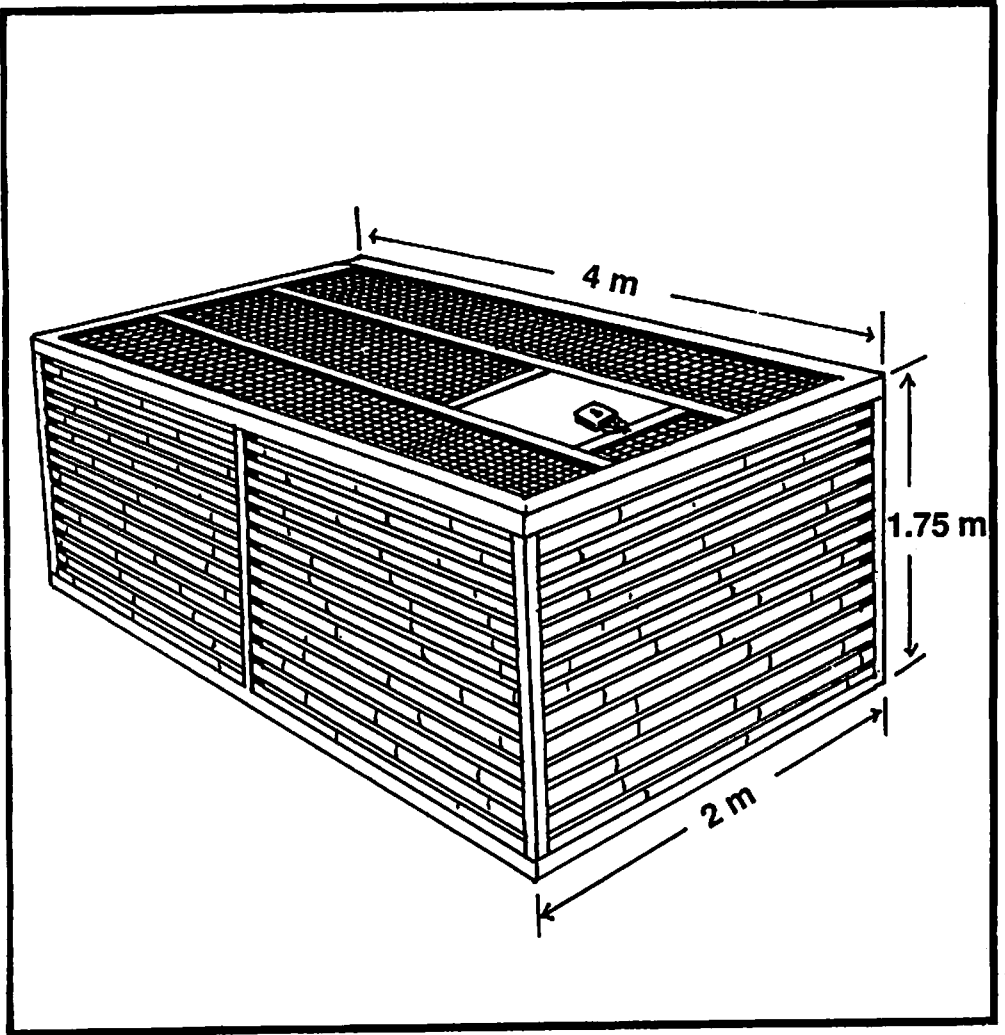

On the top of the cage, install a door with a lock for security.

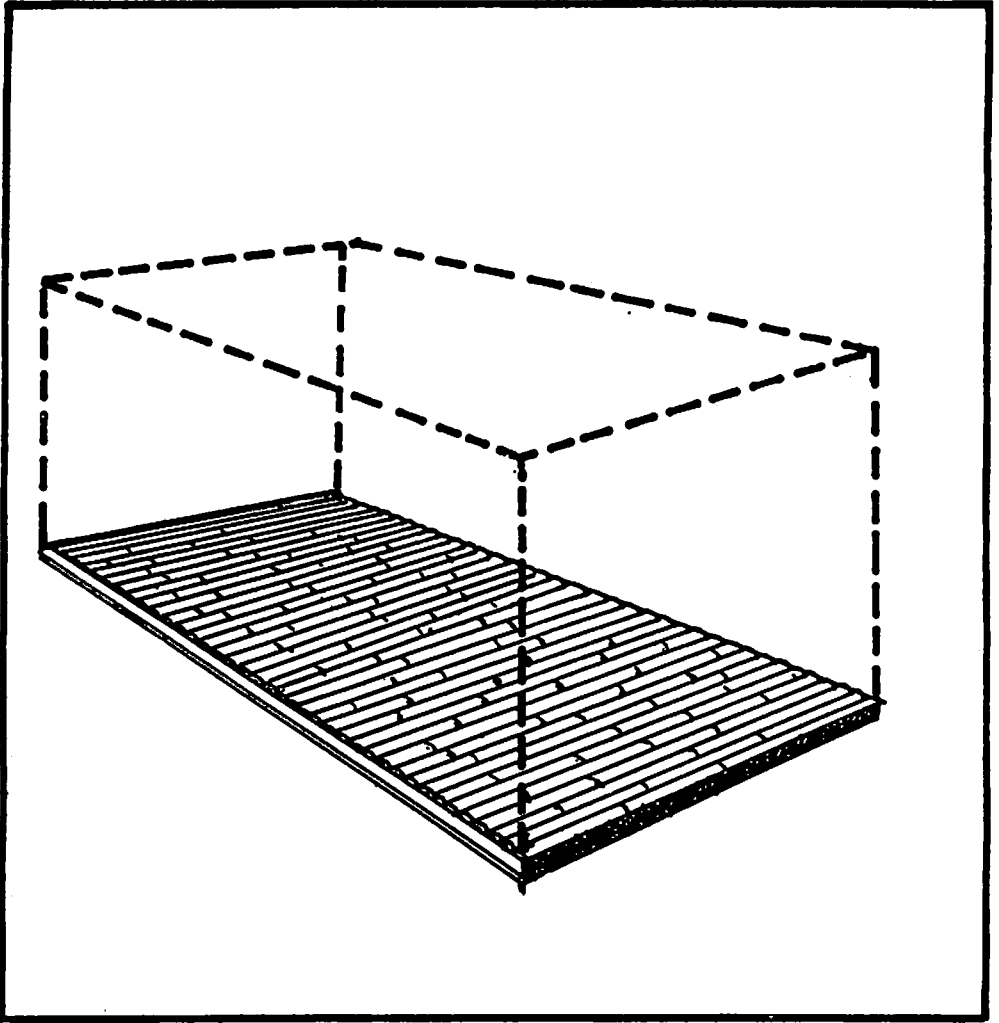

The bamboo at the bottom of the cage should be as close together as possible to avoid the loss of feed pellets which sink to the cage bottom.

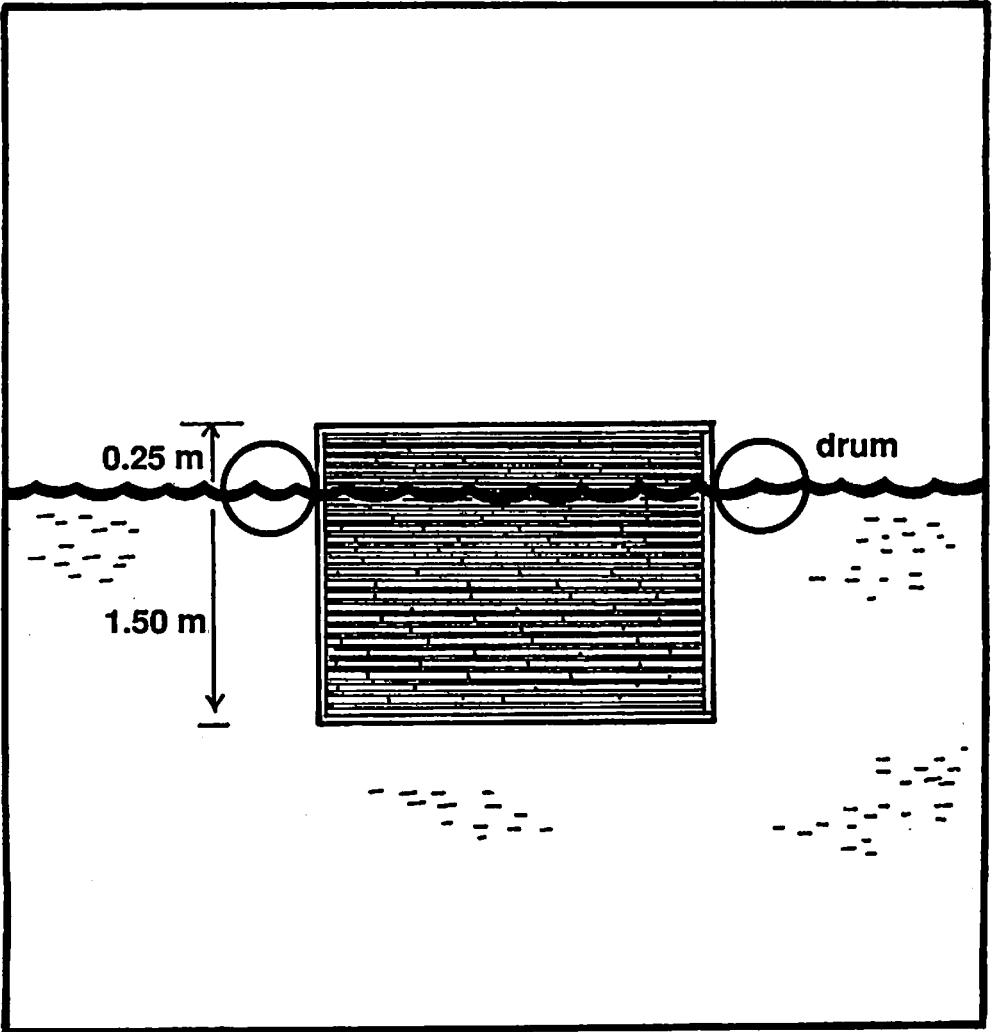

The cage should float in the water at a depth of 1.5 m.

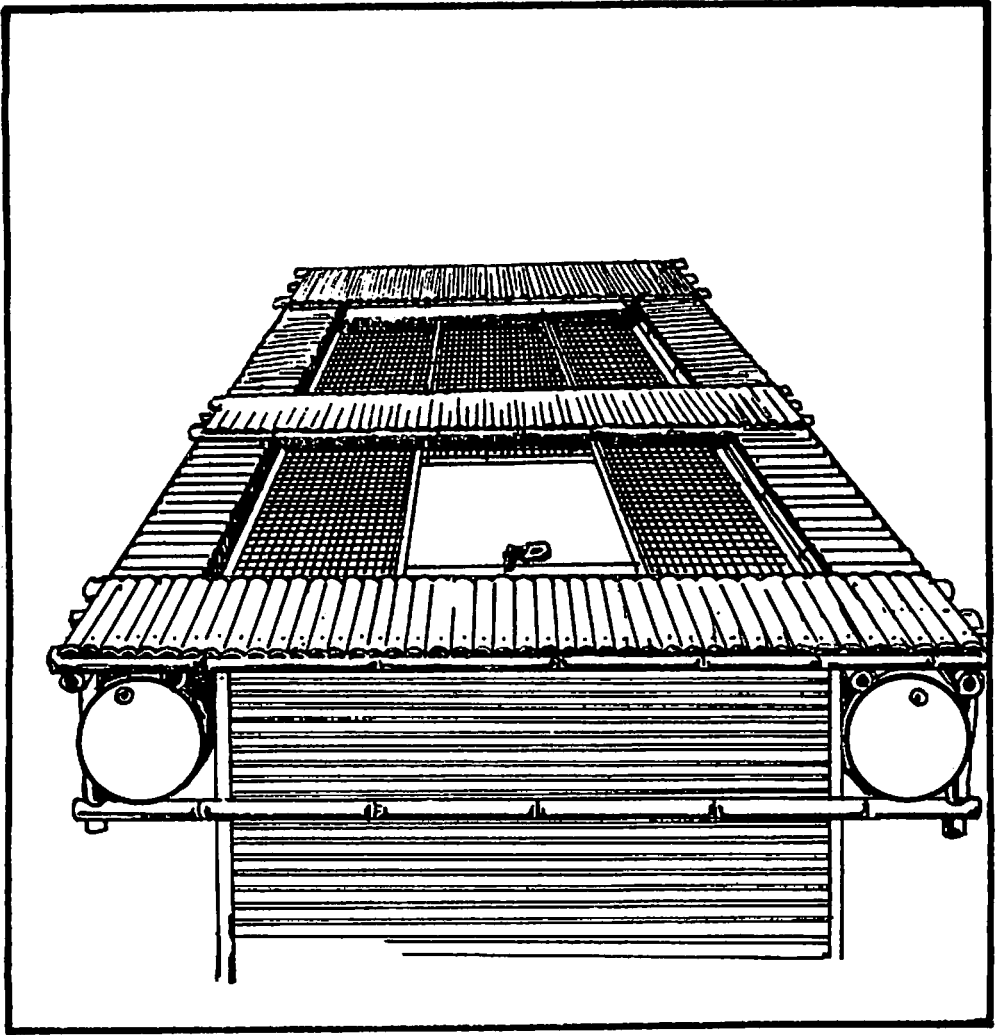

To float the cage, use drums and a bamboo raft.

- a sunny place
- near your home
- in deep water
- where gentle water currents and winds bring clean water into the cage

The best place for a cage is:

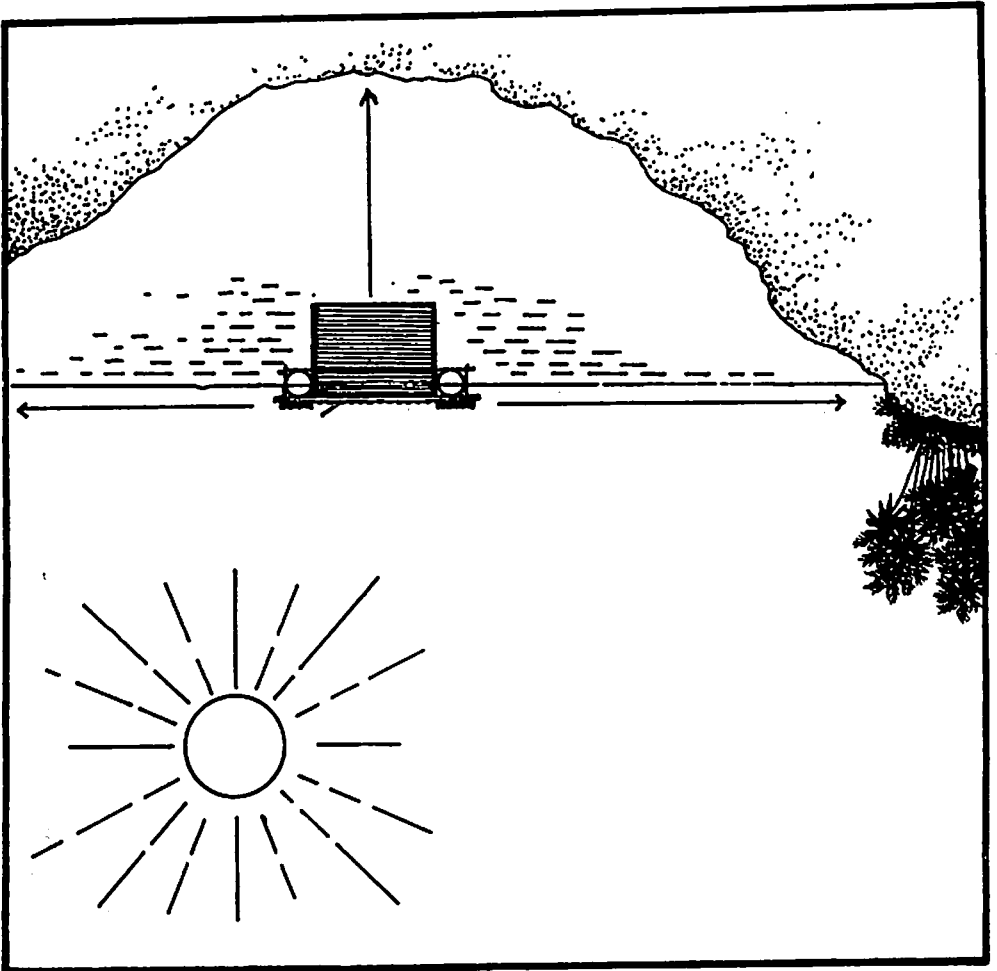

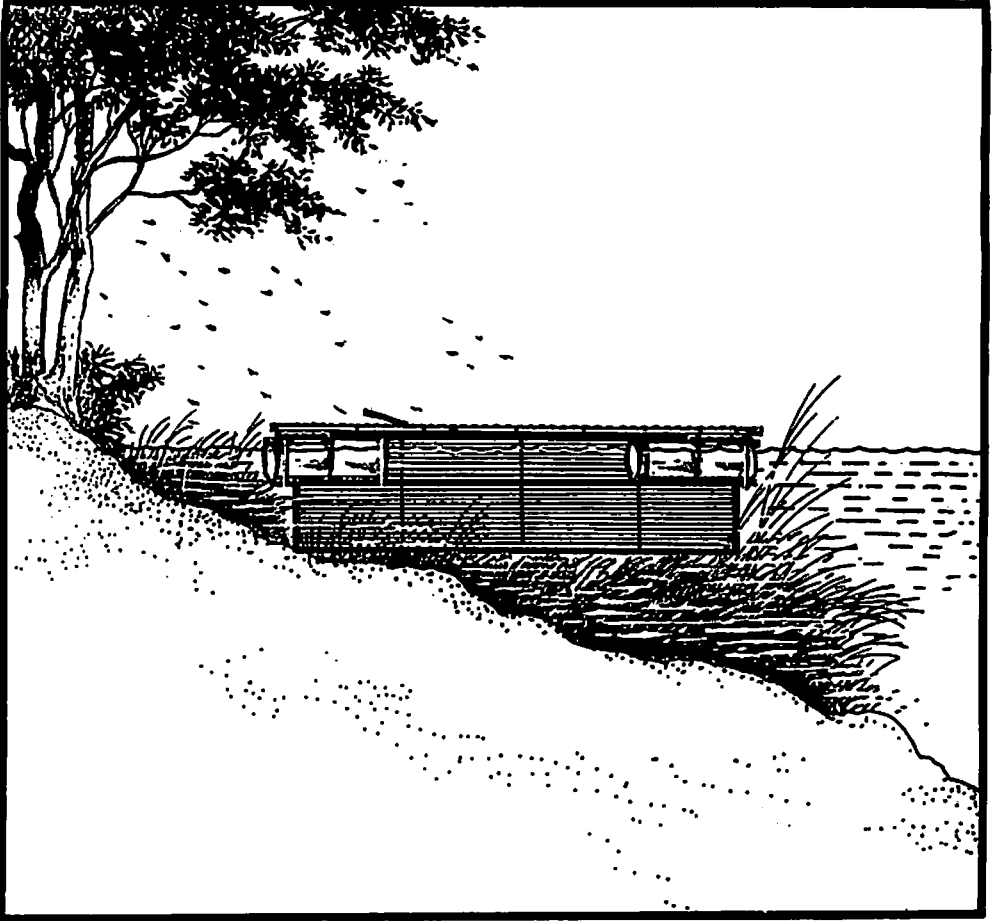

Places to avoid:

- shallow water
- places with much weeds/garbage or wastes
- places without water circulation or gentle winds
- places where more than 5 units are close together

Fish in these places get sick and die easily.

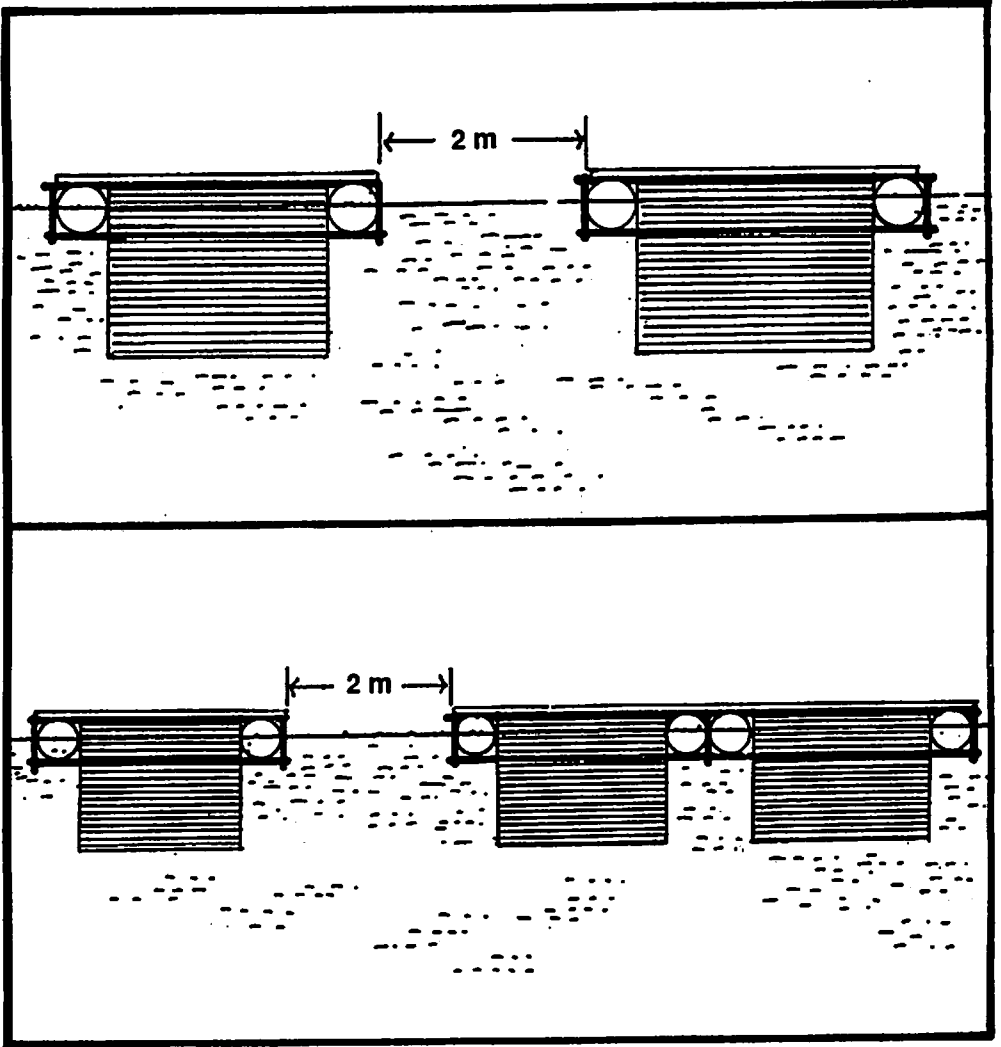

Keep the cages at least 2 m apart, enough for a small boat to pass and for small waves and wind to circulate in between cages.

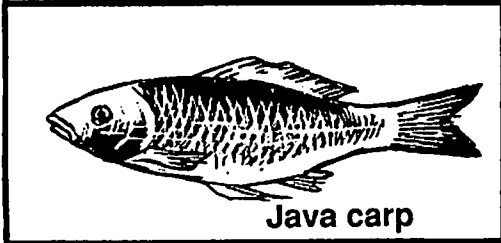
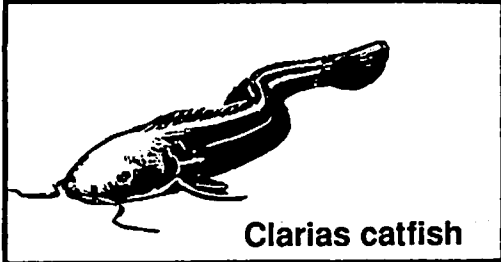
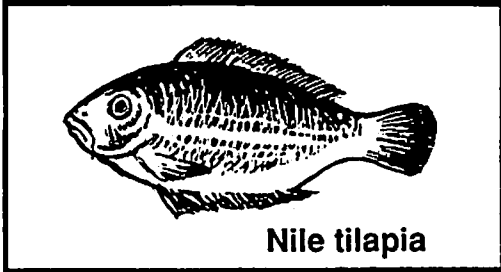
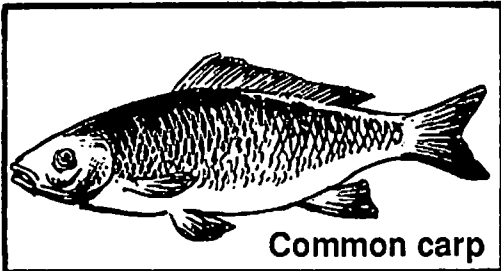

Fish that can be grown in cages



Seed fish are usually available in small village hatcheries.



How to handle and stock fish in cages:

1. Every cage needs 35 kg or 700 fish of a 50-g size (2-finger size).
2. Pack the fish seed in plastic bags with water and oxygen.

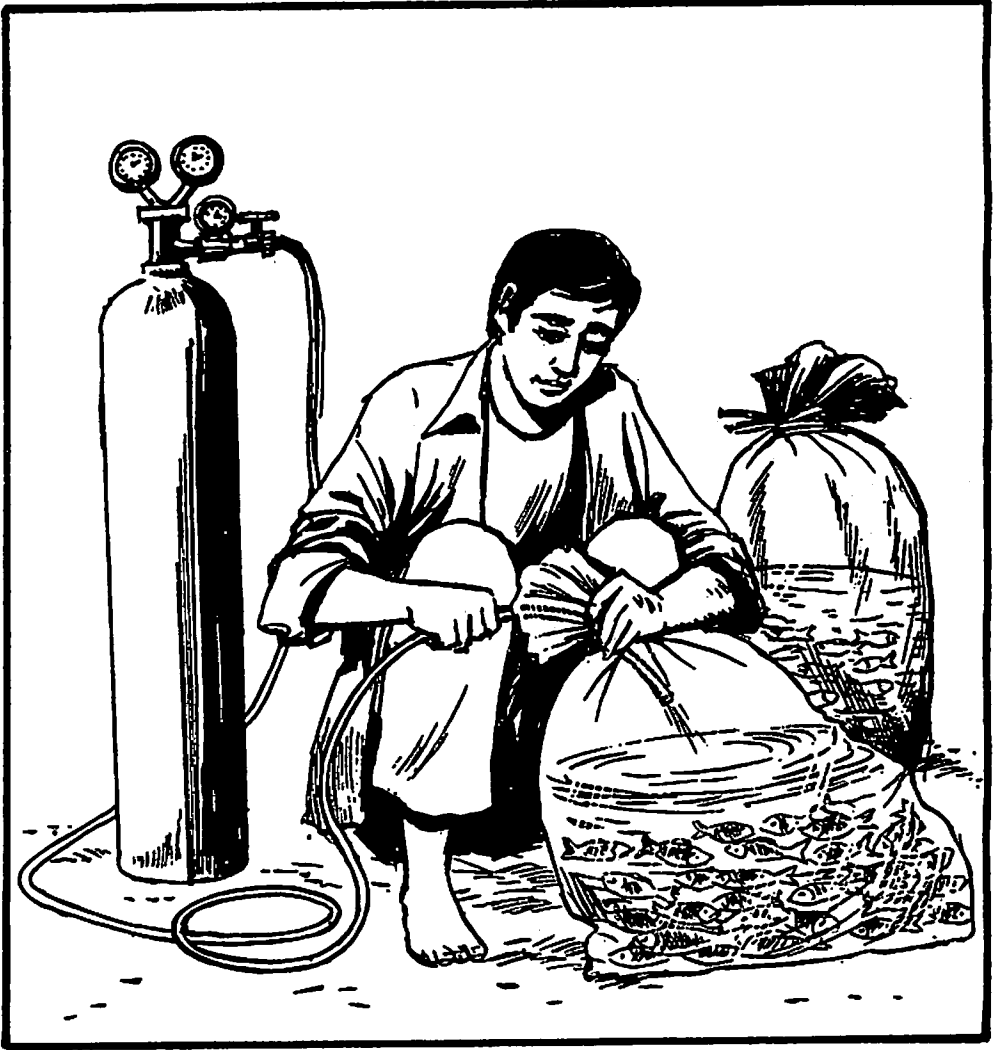

Fish need oxygen to stay alive in plastic bags.



To transport live fish in plastic bags, add oxygen so the fish can breathe.



Lower water temperature in the bags by first floating the plastic bags in the lake for 15-20 minutes.

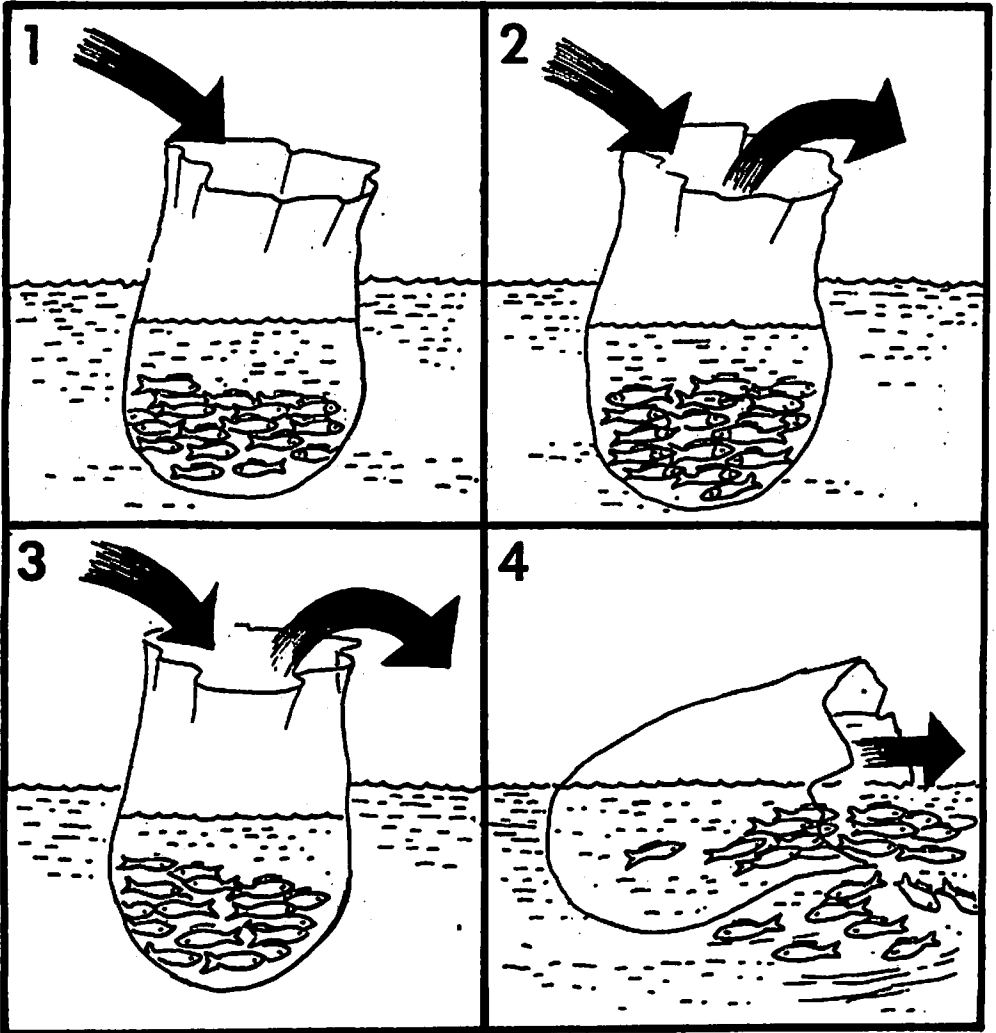

During fish transportation, the temperature of the water in the plastic bags may get high. Before stocking fish into cages, safely lower the water temperature to the same temperature as the water in the fish cage by splashing water into the bags and letting fish swim out.



When the water in the bags is the same temperature as the cage, stock the fish into the cage.

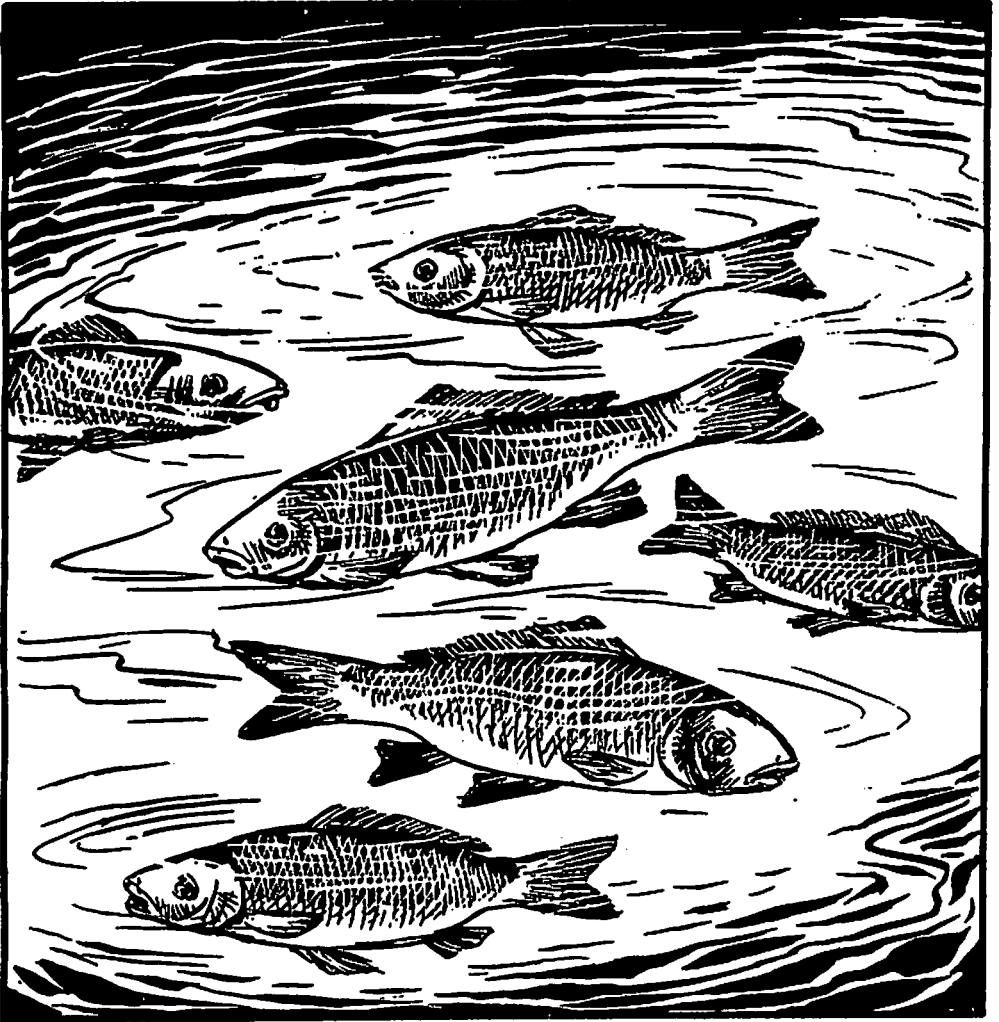

After stocking, do not disturb the fish for two days. They need time to recover and become accustomed to their new environment in the cage.



Feeding the fish:

Open the lid of the cage. Fish will come to the water surface if they are hungry. Spread the feed all around the cage surface so that all the fish are fed.

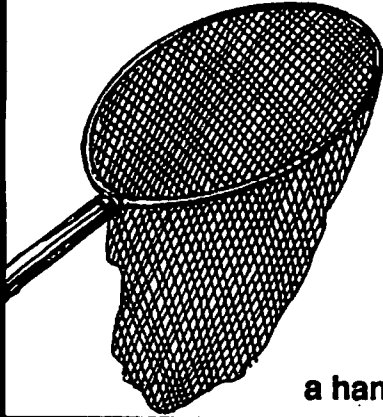

a hand net

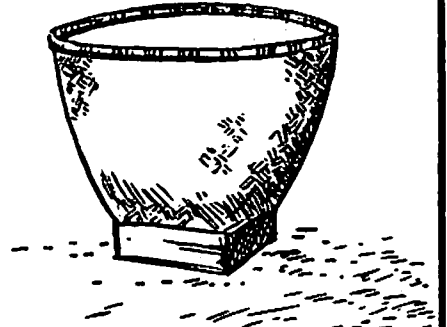

a basket

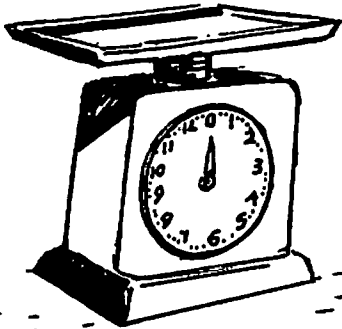

a scale



feed

As a cage operator, you will need a hand net, a basket, a scale and feed. You can make your own fish feed.



We should know the weight of fish in the cage in order to feed fish properly.

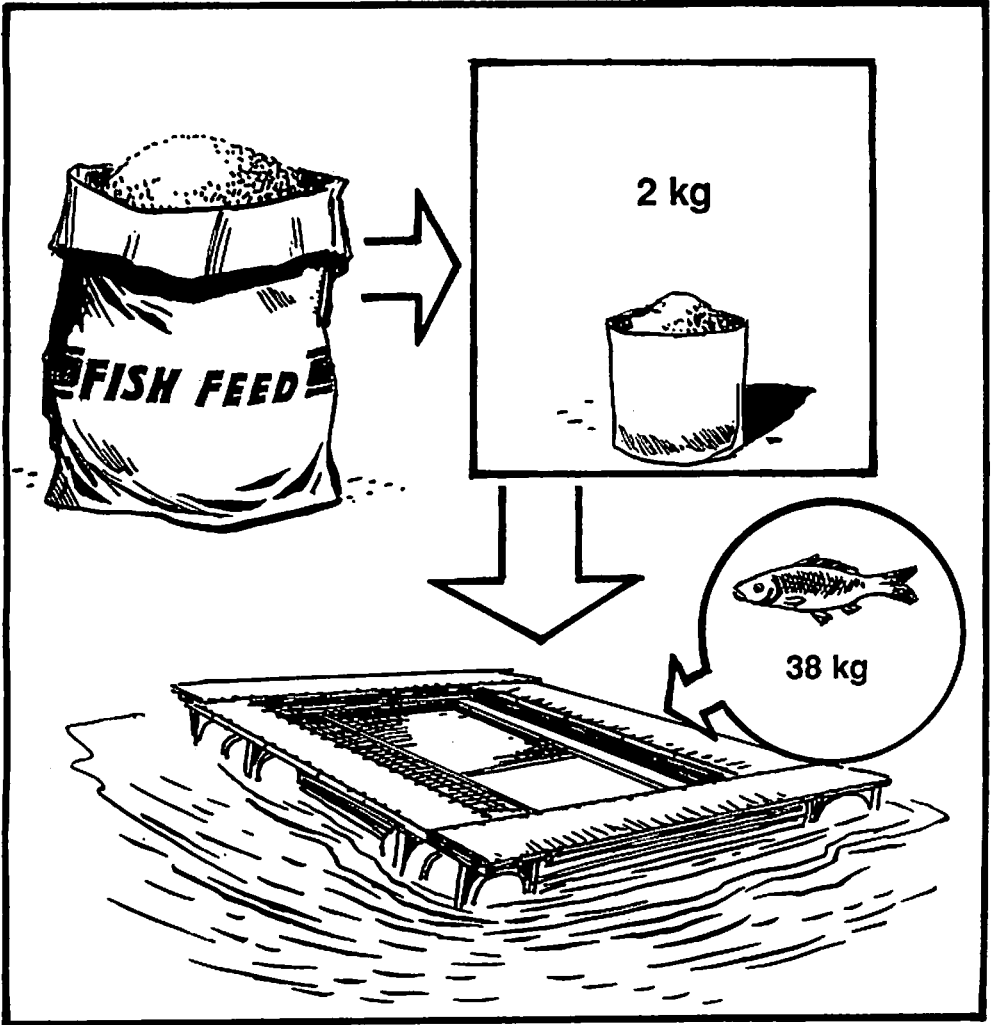

Every two weeks increase the feeding rate by 2 kg/day.

week	feeding rate (kg/day)
0	2
2	4
4	6
6	8
8	10
10	12
12	14
14	16
16	18

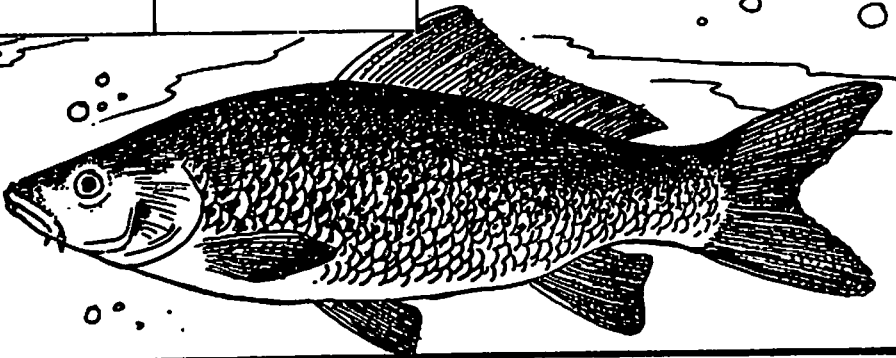

The feeding table shows how the daily feeding rate should be increased every two weeks.

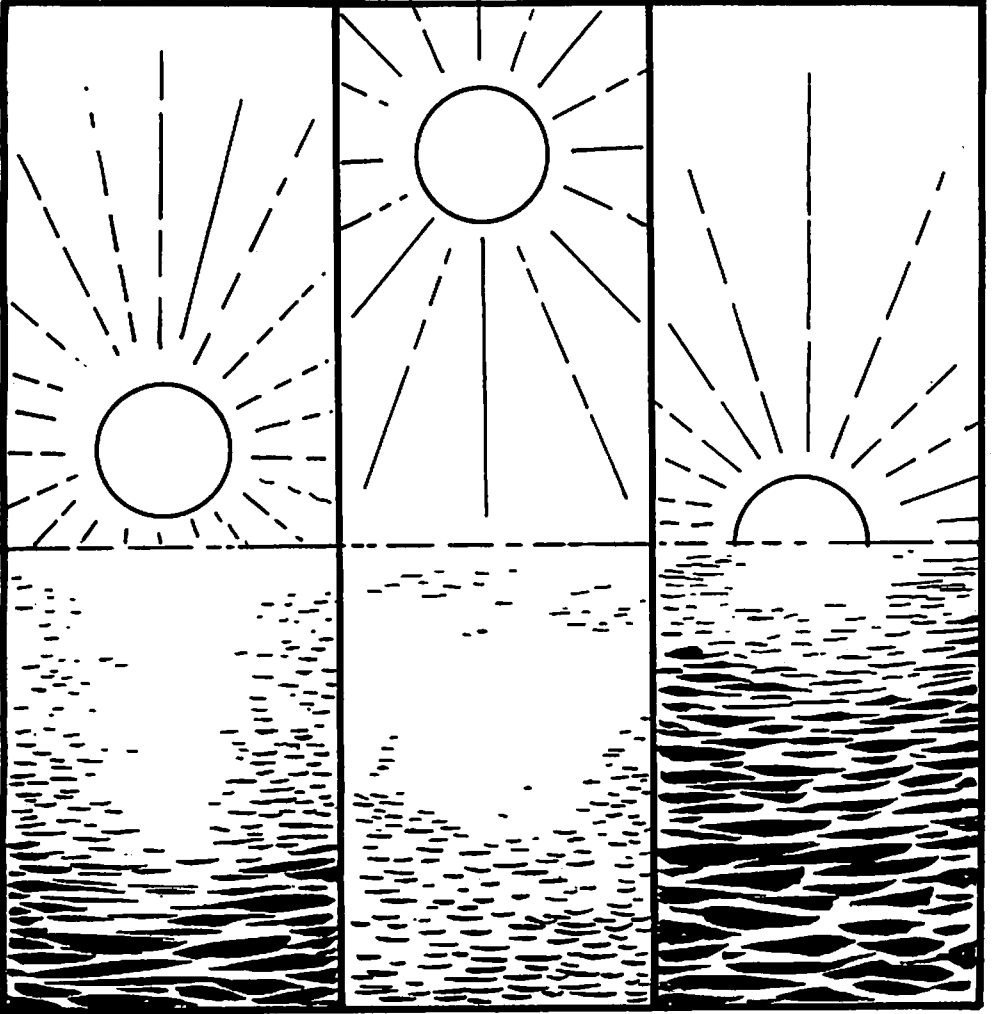

Divide the daily feed ration by three and use this to feed the fish three times a day

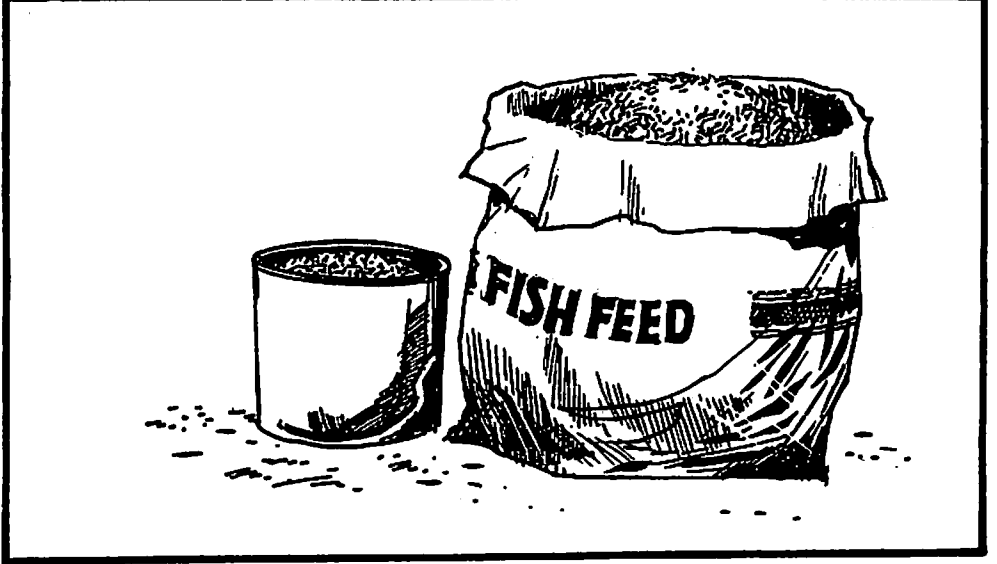
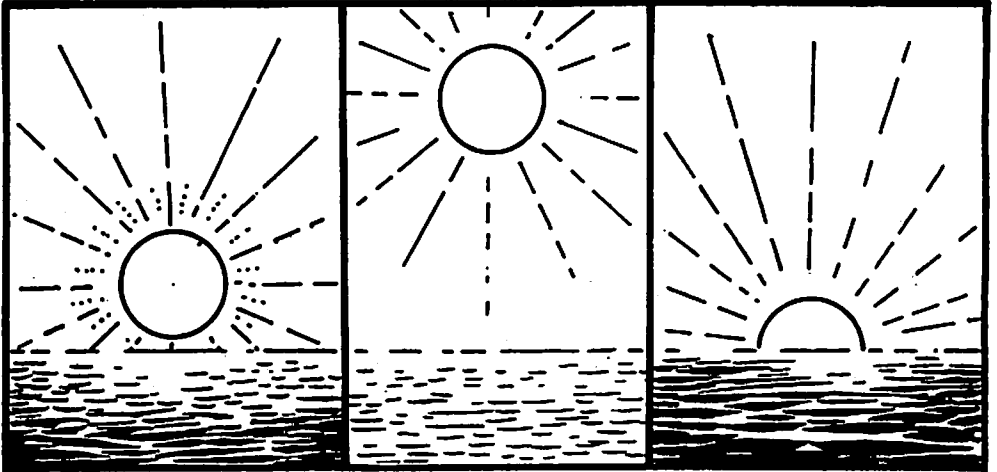

Feed fish in the early morning, during midday and around sunset.

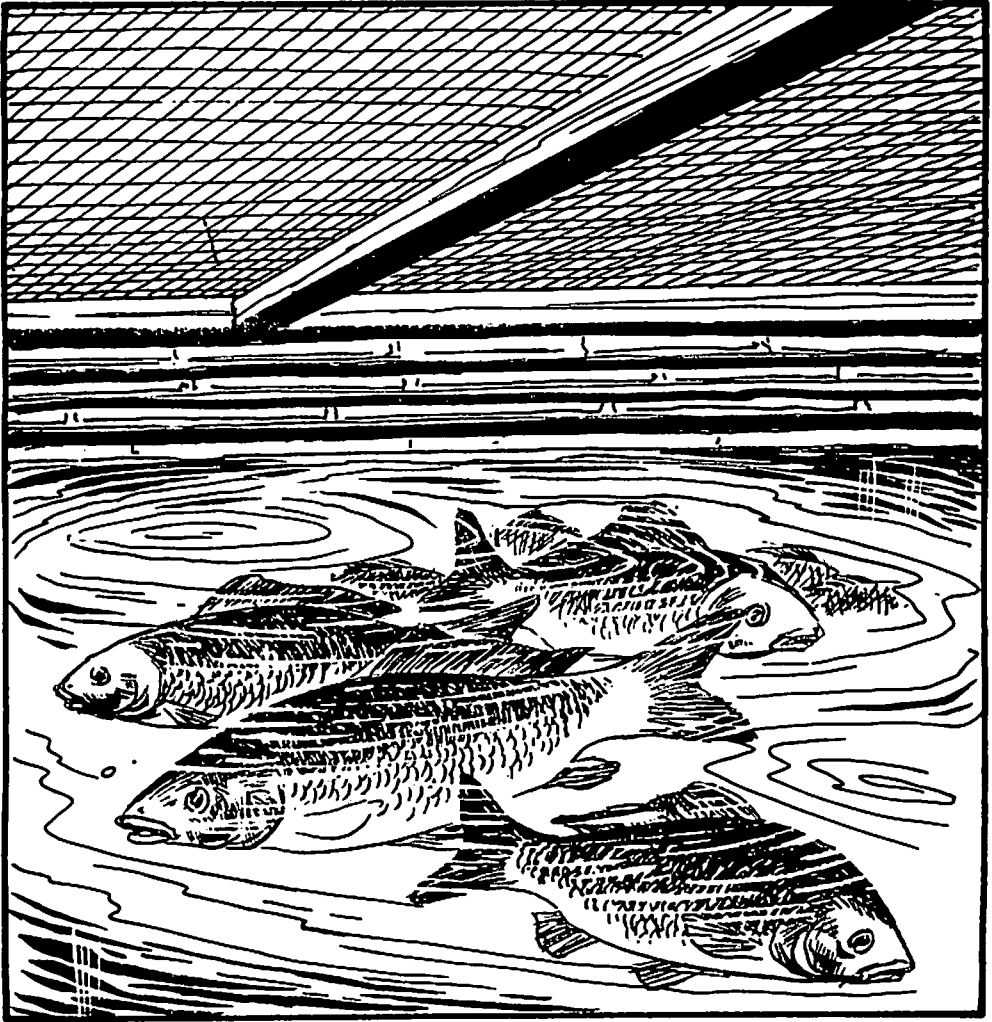

If the fish are not fed daily, they will be weak and thin.



After 3-4 months you can harvest and sell the fish at the market.

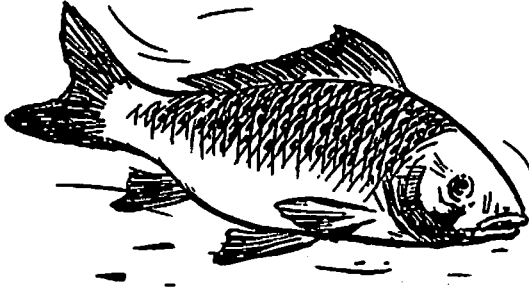

= live fish



= dead fish



Try to sell your fish live. Live fish fetch a higher price than dead ones.



To avoid fish from becoming stressed, harvest them early in the morning and transport them in covered drums or plastic bags with water.



Many fish farming families who have used the cage culture system have increased their incomes from culturing fish.

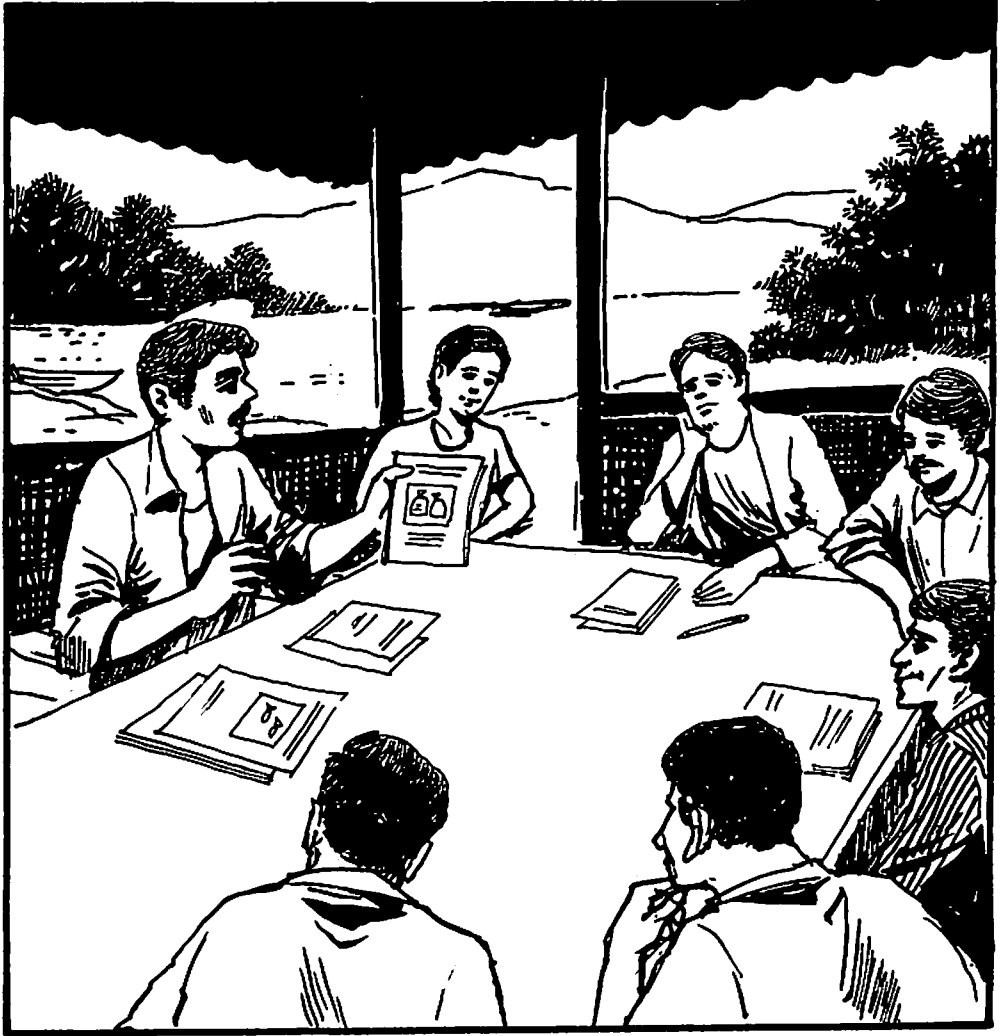

Don't forget to share your knowledge and teach your neighbors and family how to be successful fish farmers.

Units of measure

kg = kilogram

g = gram

cm = centimeter

m = meter

m³ = cubic meter